

# Low Power RS485 Transceiver with Carrier Detect and Receiver Fail-Safe

## FEATURES

- No Damage or Latchup to  $\pm 15\text{kV}$  (Human Body Model), IEC1000-4-2 Level 4 ( $\pm 8\text{kV}$ ) Contact and Level 3 ( $\pm 8\text{kV}$ ) Air Discharge
- Active Low Carrier Detect Output
- Guaranteed High Receiver Output State for Floating, Shorted or Terminated Inputs with No Signal Present
- Drives Low Cost Residential Telephone Wires
- Low Power:  $I_{CC} = 700\mu\text{A}$  Max with Driver Disabled
- $I_{CC} = 900\mu\text{A}$  Max in Driver Mode Without Load
- $20\mu\text{A}$  Max Quiescent Current in Shutdown Mode
- Single 5V Supply
- $-7\text{V}$  to  $12\text{V}$  Common Mode Range Permits  $\pm 7\text{V}$  Ground Difference Between Devices on the Data Line
- Maximum Data Rate of 4Mbps
- Power Up/Down Glitch-Free Driver Outputs
- Up to 32 Transceivers on the Bus
- Available in 8-Lead **MSOP**, PDIP and SO Packages

## APPLICATIONS

- Battery-Powered RS485/RS422 Applications
- Low Power RS485/RS422 Transceiver
- Level Translator

## DESCRIPTION

The LTC<sup>®</sup>1482 is a low power RS485 compatible transceiver that offers an active low carrier detect output. The open-drain carrier detect pin allows several transceivers to share the same carrier detect line and can be used to detect the insertion or removal of a driven RS485/RS422 cable.

Enhanced ESD protection allows the LTC1482 to withstand  $\pm 15\text{kV}$  (human body model), IEC-1000-4-2 level 4 ( $\pm 8\text{kV}$ ) contact and level 3 ( $\pm 8\text{kV}$ ) air discharge ESD without latchup or damage.

The LTC1482 receiver stays alive at all times except in shutdown. The supply current is a maximum of  $700\mu\text{A}$  and  $900\mu\text{A}$  when the driver is disabled and enabled respectively. In shutdown, the quiescent current of the LTC1482 drops to a maximum of  $20\mu\text{A}$ .

When the driver is disabled or the LTC1482 is in shutdown, the driver outputs are three-stated and remain in a high impedance state over the RS485 common mode range.

Excessive power dissipation caused by bus contention or faults is prevented by a thermal shutdown circuit, which forces the driver outputs into a high impedance state.

The LTC1482 is fully specified over the commercial and industrial temperature ranges and is available in 8-lead MSOP, PDIP and SO packages.

 LTC and LT are registered trademarks of Linear Technology Corporation.

## TYPICAL APPLICATION

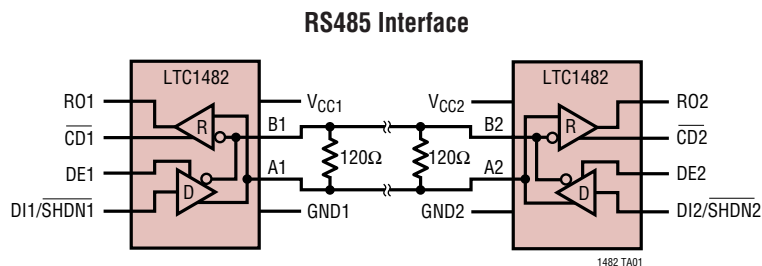

Carrier Detect Output (2000 Foot STP Cable)

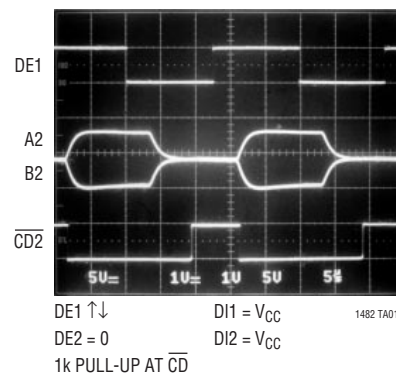

## ABSOLUTE MAXIMUM RATINGS

(Note 1)

Supply Voltage ( $V_{CC}$ ) .....	6.5V	Junction Temperature .....	125°C
Control Input Voltages .....	-0.3V to ( $V_{CC} + 0.3V$ )	Operating Temperature Range	
Carrier Detect Voltage .....	-0.3V to 8V	LTC1482C .....	$0^{\circ}\text{C} \leq T_A \leq 70^{\circ}\text{C}$
Driver Input Voltage .....	-0.3V to ( $V_{CC} + 0.3V$ )	LTC1482I .....	$-40^{\circ}\text{C} \leq T_A \leq 85^{\circ}\text{C}$
Driver Output Voltages .....	-7V to 10V	Storage Temperature Range .....	$-65^{\circ}\text{C}$ to $150^{\circ}\text{C}$
Receiver Input Voltages (Driver Disabled) ..	-12V to 14V	Lead Temperature (Soldering, 10 sec) .....	300°C
Receiver Output Voltage .....	-0.3V to ( $V_{CC} + 0.3V$ )		

## PACKAGE/ORDER INFORMATION

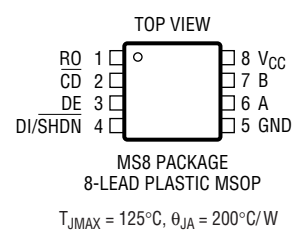
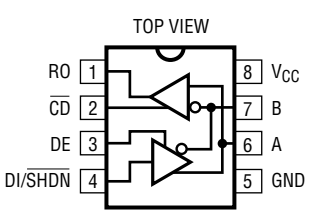
 <p>MS8 PACKAGE 8-LEAD PLASTIC MSOP <math>T_{JMAX} = 125^{\circ}\text{C}</math>, <math>\theta_{JA} = 200^{\circ}\text{C/W}</math></p>	ORDER PART NUMBER	 <p>N8 PACKAGE 8-LEAD PDIP <math>T_{JMAX} = 125^{\circ}\text{C}</math>, <math>\theta_{JA} = 130^{\circ}\text{C/W}</math> (N8) <math>T_{JMAX} = 125^{\circ}\text{C}</math>, <math>\theta_{JA} = 135^{\circ}\text{C/W}</math> (S8)</p>	ORDER PART NUMBER
	LTC1482CMS8		LTC1482CN8 LTC1482CS8 LTC1482IN8 LTC1482IS8
	MS8 PART MARKING		S8 PART MARKING
	LTCB		1482 1482I

Consult factory for Military grade parts.

## ELECTRICAL CHARACTERISTICS

The ● denotes the specifications which apply over the full operating temperature range, otherwise specifications are at  $T_A = 25^{\circ}\text{C}$ .  $V_{CC} = 5V \pm 5\%$  (Notes 2 and 3) unless otherwise noted.

SYMBOL	PARAMETER	CONDITIONS	MIN	TYP	MAX	UNITS
$V_{OD1}$	Differential Driver Output Voltage (Unloaded)	$I_{OUT} = 0$	●		$V_{CC}$	V
$V_{OD2}$	Differential Driver Output Voltage (with Load)	$R = 50\Omega$ (RS422)	●	2		V
		$R = 27\Omega$ (RS485) Figure 1	●	1.5	5	V
		$R = 22\Omega$ , Figure 1	●	1.5	5	V
$V_{OD3}$	Differential Driver Output Voltage (with Common Mode)	$V_{TST} = -7V$ to 12V, Figure 2	●	1.5	5	V
$\Delta V_{OD}$	Change in Magnitude of Driver Differential Output Voltage for Complementary Output States	$R = 22\Omega, 27\Omega$ or $R = 50\Omega$ , Figure 1 $V_{TST} = -7V$ to 12V, Figure 2	●		0.2	V
$V_{OC}$	Driver Common Mode Output Voltage	$R = 22\Omega, 27\Omega$ or $R = 50\Omega$ , Figure 1	●		3	V
$\Delta V_{OC} $	Change in Magnitude of Driver Common Mode Output Voltage for Complementary Output States	$R = 22\Omega, 27\Omega$ or $R = 50\Omega$ , Figure 1	●		0.2	V
$V_{IH}$	Input High Voltage	DE, DI/SHDN	●	2		V
$V_{IL}$	Input Low Voltage	DE, DI/SHDN	●		0.8	V
$I_{IN1}$	Input Current	DE, DI/SHDN	●		$\pm 2$	$\mu\text{A}$
$I_{IN2}$	Input Current (A, B) with Driver Disabled	DE = 0, $V_{CC} = 0$ or 5V, $V_{IN} = 12V$	●		1.0	mA
		DE = 0, $V_{CC} = 0$ or 5V, $V_{IN} = -7V$	●		-0.8	mA
$V_{THRO}$	Differential Input Threshold Voltage for Receiver	$-7V \leq V_{CM} \leq 12V$ , DE = 0	●	-0.20	-0.015	V

## ELECTRICAL CHARACTERISTICS

The ● denotes the specifications which apply over the full operating temperature range, otherwise specifications are at  $T_A = 25^\circ\text{C}$ .  $V_{CC} = 5V \pm 5\%$  (Notes 2 and 3) unless otherwise noted.

SYMBOL	PARAMETER	CONDITIONS	MIN	TYP	MAX	UNITS	
$V_{THCD}$	Differential Input Threshold Voltage for $\overline{CD} = 1$	$-7V \leq V_{CM} \leq 12V$ , $DE = 0$	●	-0.20	0.20	V	
$\Delta V_{TH}$	Receiver Input Hysteresis	$V_{CM} = 0V$ , $DE = 0$		±30		mV	
$V_{OH}$	$\overline{CD}$ Output High Voltage	$I_{OUT} = -10\mu\text{A}$ , $(V_A - V_B) = 0V$	●	3.4		V	
	RO Output High Voltage	$I_{OUT} = -4\text{mA}$ , $(V_A - V_B) = 200\text{mV}$	●	3.5		V	
$V_{OL}$	RO and $\overline{CD}$ Output Low Voltage	$I_{OUT} = 4\text{mA}$ , $(V_A - V_B) = -200\text{mV}$	●		0.4	V	
$I_{OZR}$	Three-State (High Impedance) Receiver Output Current in Shutdown	$V_{CC} = \text{Max}$ , $0.4V \leq V_{OUT} \leq 2.4V$ $DI/\text{SHDN} = 0$ , $DE = 0$	●		±1	$\mu\text{A}$	
$R_{IN}$	Receiver Input Resistance	$-7V \leq V_{CM} \leq 12V$	●	12	22	k $\Omega$	
$I_{CC}$	Supply Current	No Load, Driver Enabled ( $DE = V_{CC}$ )	●	580	900	$\mu\text{A}$	
		No Load, Driver Disabled ( $DE = 0$ )	●	430	700	$\mu\text{A}$	
$I_{SHDN}$	Supply Current in Shutdown Mode	$DE = 0$ , $DI = 0$	●	10	20	$\mu\text{A}$	
$I_{OSD1}$	Driver Short-Circuit Current, $V_{OUT} = \text{High}$ (Note 4)	$-7V \leq V_{OUT} \leq 10V$		35	250	mA	
$I_{OSD2}$	Driver Short-Circuit Current, $V_{OUT} = \text{Low}$ (Note 4)	$-7V \leq V_{OUT} \leq 10V$		35	250	mA	
$I_{OS}$	RO and $\overline{CD}$ Short-Circuit Current	$0V \leq V_{OUT} \leq V_{CC}$	●	7	85	mA	
$I_{PULL-UP}$	$\overline{CD}$ Pull-Up Current	$\overline{CD} = 0V$	●	15	30	60	$\mu\text{A}$

## SWITCHING CHARACTERISTICS

The ● denotes the specifications which apply over the full operating temperature range, otherwise specifications are at  $T_A = 25^\circ\text{C}$ .  $V_{CC} = 5V \pm 5\%$  (Notes 2 and 3) unless otherwise noted.

SYMBOL	PARAMETER	CONDITIONS	MIN	TYP	MAX	UNITS	
$t_{PLH}$	Driver Input to Output	$R_{DIFF} = 54\Omega$ , $C_{L1} = C_{L2} = 100\text{pF}$	●	10	28	60	ns
$t_{PHL}$	Driver Input to Output	(Figures 4, 6)	●	10	30	60	ns
$t_{SKEW}$	Driver Output to Output		●	2	10	ns	
$t_r$ , $t_f$	Driver Rise or Fall Time		●	3	15	40	ns
$t_{ZH}$	Driver Enable to Output High	$C_L = 100\text{pF}$ (Figures 5, 7) S2 Closed	●	40	70	ns	
$t_{ZL}$	Driver Enable to Output Low	$C_L = 100\text{pF}$ (Figures 5, 7) S1 Closed	●	40	100	ns	
$t_{LZ}$	Driver Disable Time from Low	$C_L = 15\text{pF}$ (Figures 5, 7) S1 Closed	●	40	70	ns	
$t_{HZ}$	Driver Disable Time from High	$C_L = 15\text{pF}$ (Figures 5, 7) S2 Closed	●	40	70	ns	
$t_{ZH}(\text{SHDN})$	Driver Enable from Shutdown to Output High (Note 5)	$C_L = 100\text{pF}$ (Figures 5, 7) S2 Closed	●	40	100	ns	
$t_{ZL}(\text{SHDN})$	Driver Enable from Shutdown to Output Low	$C_L = 100\text{pF}$ (Figures 5, 7) S1 Closed	●	40	100	ns	
$t_{HZ}(\text{SHDN})$	Driver Disable on Shutdown from Output High	$C_L = 15\text{pF}$ (Figures 5, 7) S2 Closed	●	40	100	ns	
$t_{LZ}(\text{SHDN})$	Driver Disable on Shutdown from Output Low	$C_L = 15\text{pF}$ (Figures 5, 7) S1 Closed	●	40	100	ns	
$f_{MAX}$	Maximum Data Rate (Note 6)		●	4	5	Mbps	
$t_{PLH}$	Receiver Input to Output (Note 7)	$R_{DIFF} = 54\Omega$ , $C_{L1} = C_{L2} = 100\text{pF}$ , (Figures 4, 8)	●	30	138	200	ns
$t_{PHL}$	Receiver Input to Output	$R_{DIFF} = 54\Omega$ , $C_{L1} = C_{L2} = 100\text{pF}$ , (Figures 4, 8)	●	30	122	200	ns
$t_{SKD}$	$ t_{PLH} - t_{PHL} $ Differential Receiver Skew	$R_{DIFF} = 54\Omega$ , $C_{L1} = C_{L2} = 100\text{pF}$ , (Figures 4, 8)			16	ns	
$t_{CDH}$	Receiver Input to $\overline{CD}$ Output High (Note 7)	$R_{DIFF} = 54\Omega$ , $C_{L1} = C_{L2} = 100\text{pF}$ , (Figures 4, 10) $DI/\text{SHDN} = V_{CC}$	●	2900	5000	ns	
$t_{CDL}$	Receiver Input to $\overline{CD}$ Output Low (Note 7)	$R_{DIFF} = 54\Omega$ , $C_{L1} = C_{L2} = 100\text{pF}$ , (Figures 4, 10) $DI/\text{SHDN} = V_{CC}$	●	150	300	ns	

**SWITCHING CHARACTERISTICS** The ● denotes the specifications which apply over the full operating temperature range, otherwise specifications are at  $T_A = 25^\circ\text{C}$ .  $V_{CC} = 5V \pm 5\%$  (Notes 2 and 3) unless otherwise noted.

SYMBOL	PARAMETER	CONDITIONS	MIN	TYP	MAX	UNITS
$t_{CDH(SHDN)}$	Receiver Input to $\overline{CD}$ Output High at Shutdown	$R_{DIF} = 54\Omega$ , $C_{L1} = C_{L2} = 100\text{pF}$ , (Figures 4, 11) DI/SHDN = DE ●		2600	5000	ns
$t_{CDL(SHDN)}$	Receiver Input to $\overline{CD}$ Output Low from Shutdown	$R_{DIF} = 54\Omega$ , $C_{L1} = C_{L2} = 100\text{pF}$ , (Figures 4, 11) DI/SHDN = DE ●		2600	5000	ns
$t_{ZH(SHDN)}$	Receiver Enable from Shutdown to Output High	$C_L = 15\text{pF}$ (Figures 3, 9) S2 Closed, $A = 750\text{mV}$ , $B = -750\text{mV}$ , $DE = 0$ , DI/SHDN = $\overline{DI}$ ●		30	600	ns
$t_{ZL(SHDN)}$	Receiver Enable from Shutdown to Output Low	$C_L = 15\text{pF}$ (Figures 3, 9) S1 Closed, $A = -750\text{mV}$ , $B = 750\text{mV}$ , $DE = 0$ , DI/SHDN = $\overline{DI}$ ●		2600	5000	ns
$t_{HZ(SHDN)}$	Receiver Disable from High on Shutdown	$C_L = 15\text{pF}$ (Figures 3, 9) S2 Closed, $A = 750\text{mV}$ , $B = -750\text{mV}$ , $DE = 0$ , DI/SHDN = $\overline{DI}$ ●		200	600	ns
$t_{LZ(SHDN)}$	Receiver Disable from Low on Shutdown	$C_L = 15\text{pF}$ (Figures 3, 9) S1 Closed, $A = -750\text{mV}$ , $B = 750\text{mV}$ , $DE = 0$ , DI/SHDN = $\overline{DI}$ ●		200	600	ns

**Note 1:** Absolute Maximum Ratings are those values beyond which the life of a device may be impaired.

**Note 2:** All typicals are given for  $V_{CC} = 5V$  and  $T_A = 25^\circ\text{C}$ .

**Note 3:** All currents into device pins are positive; all currents out of device pins are negative. All voltages are referenced to device ground unless otherwise specified.

**Note 4:** For higher ambient temperatures, the part may enter thermal shutdown during short-circuit conditions.

**Note 5:** Both driver input and driver enable pins are pulled high simultaneously.

**Note 6:** Guaranteed by design.

**Note 7:** Measured with an external LTC1485 driver.

**TYPICAL PERFORMANCE CHARACTERISTICS**

Receiver Output Voltage vs Input Voltage

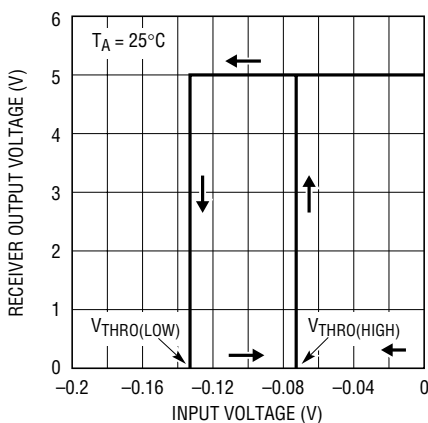

Receiver Input Threshold Voltage (Output High) vs Temperature

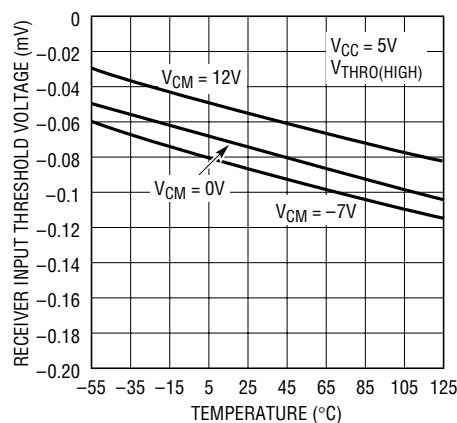

Receiver Input Threshold Voltage (Output Low) vs Temperature

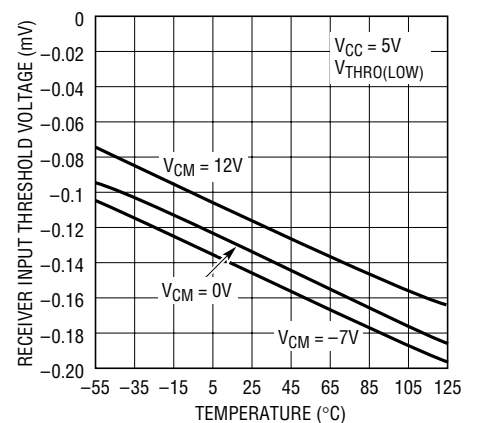

# TYPICAL PERFORMANCE CHARACTERISTICS

**Receiver Input Offset Voltage vs Temperature**

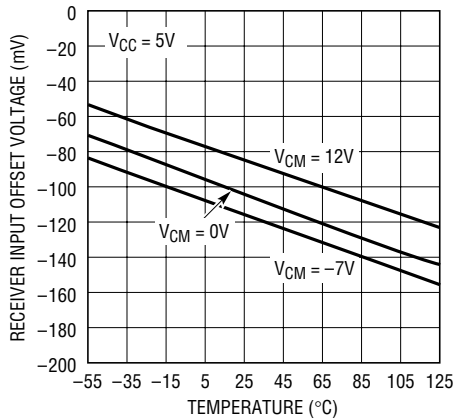

1482 G04

**Receiver Hysteresis vs Temperature**

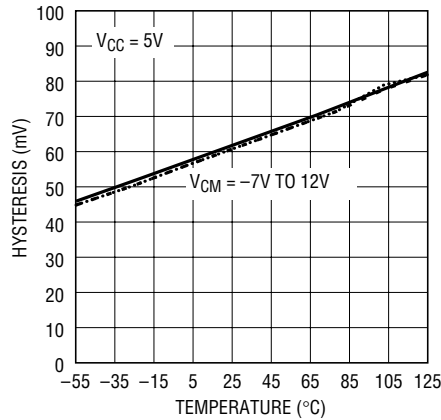

1482 G05

**Receiver Input Threshold Voltage vs Supply Voltage**

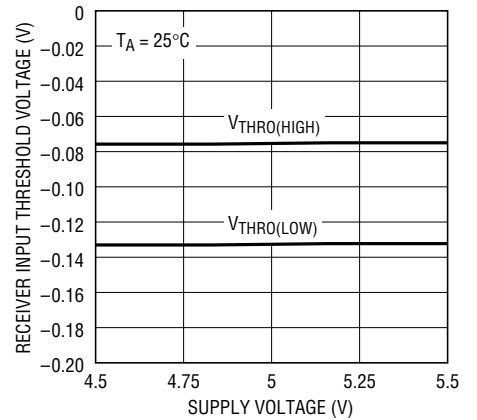

1482 G06

**Carrier Detect Output Voltage vs Receiver Input Voltage**

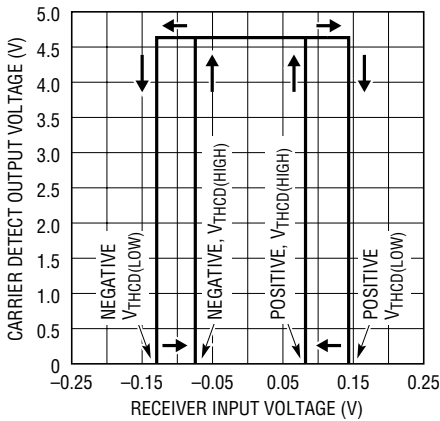

1482 G07

**Carrier Detect Threshold Voltage (Output High) vs Temperature**

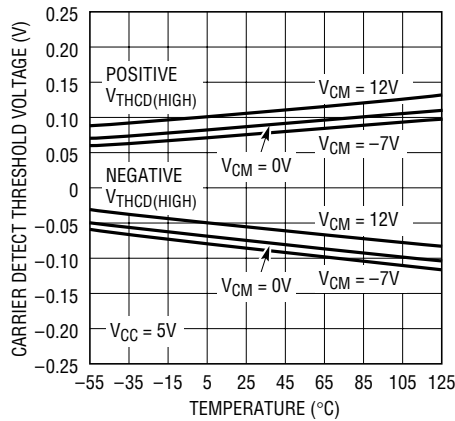

1482 G08

**Carrier Detect Threshold Voltage (Output Low) vs Temperature**

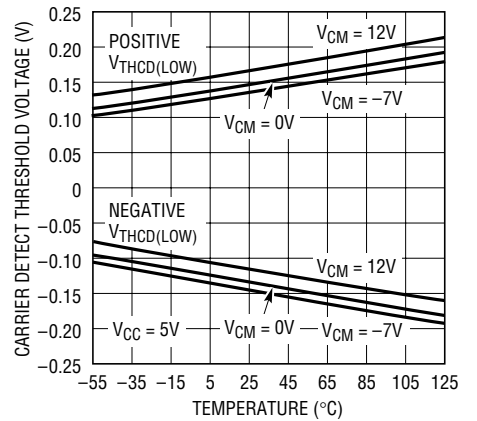

1482 G09

**Receiver Output High Voltage vs Temperature**

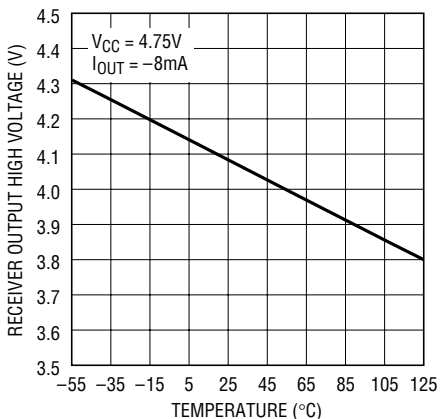

1482 G10

**Carrier Detect Output High Voltage vs Output Current**

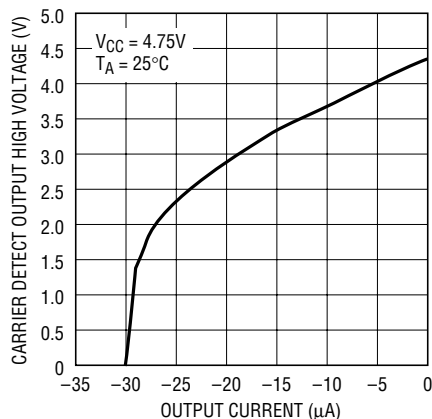

1482 G11

**Receiver and Carrier Detect Output Low Voltage vs Output Current**

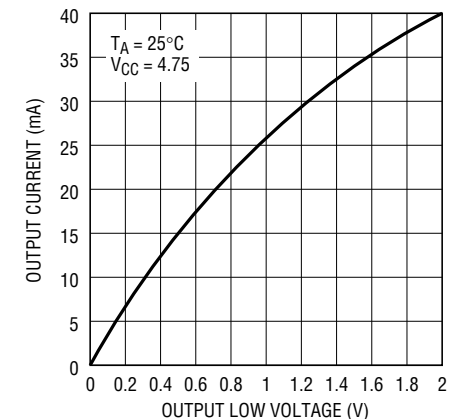

1482 G12

TYPICAL PERFORMANCE CHARACTERISTICS

Receiver Output High Voltage vs Temperature

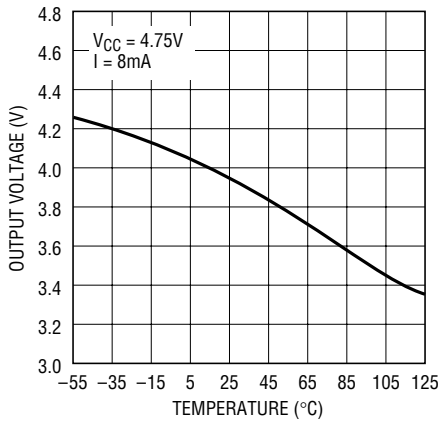

1482 G13

Carrier Detect Output High Voltage vs Temperature

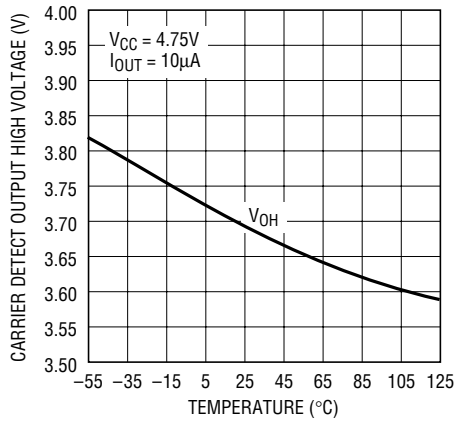

1482 G14

Receiver and Carrier Detect Output Low Voltage vs Temperature

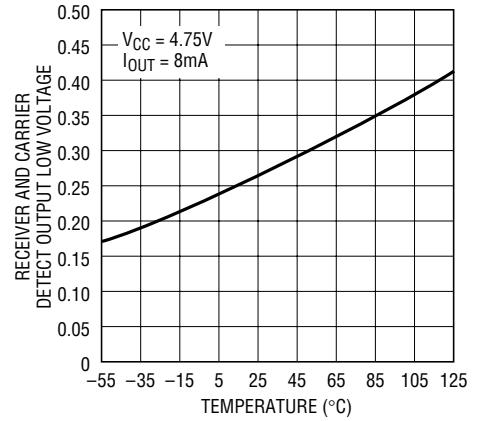

1482 G15

Receiver Propagation Delay vs Temperature

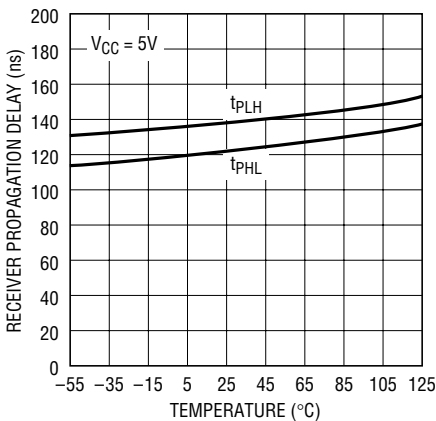

1482 G16

Receiver Skew vs Temperature

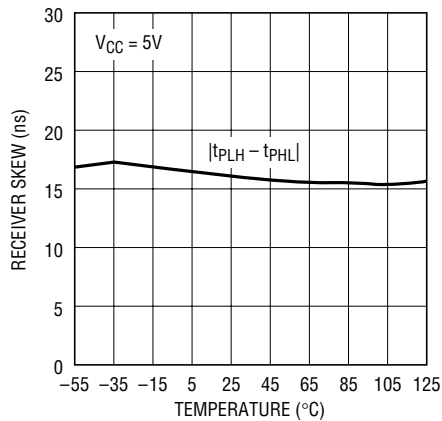

1482 G17

Receiver Propagation Delay vs Supply Voltage

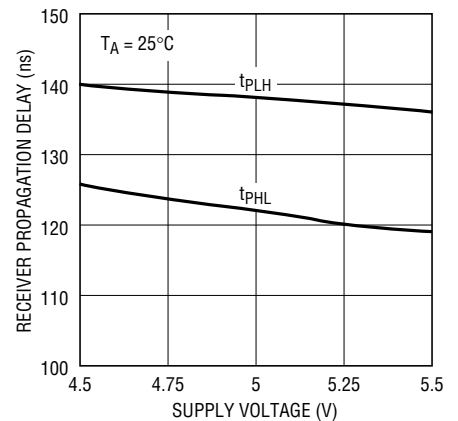

1482 G18

Receiver Short-Circuit Current vs Temperature

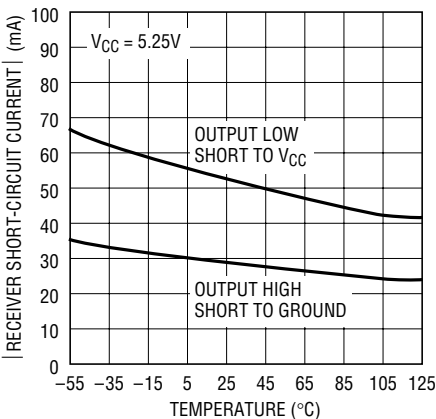

1482 G19

Supply Current vs Temperature

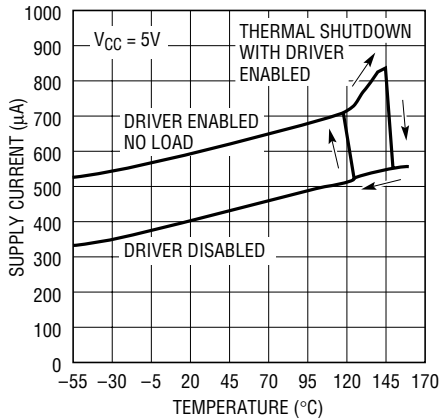

1482 G20

Logic Input Threshold vs Temperature

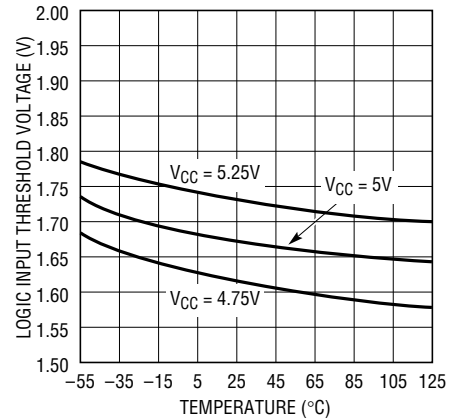

1482 G21

# TYPICAL PERFORMANCE CHARACTERISTICS

**Driver Differential Output Voltage vs Temperature**

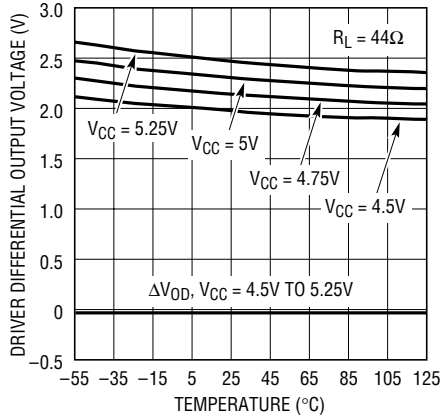

1482 G22

**Driver Differential Output Voltage vs Temperature**

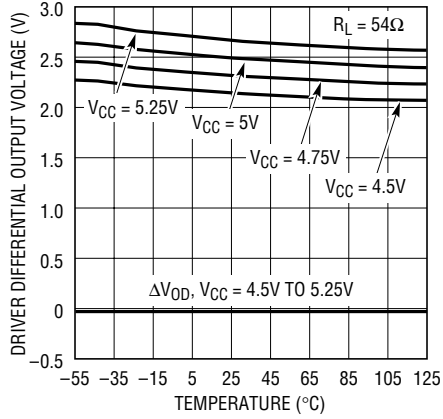

1482 G23

**Driver Differential Output Voltage vs Temperature**

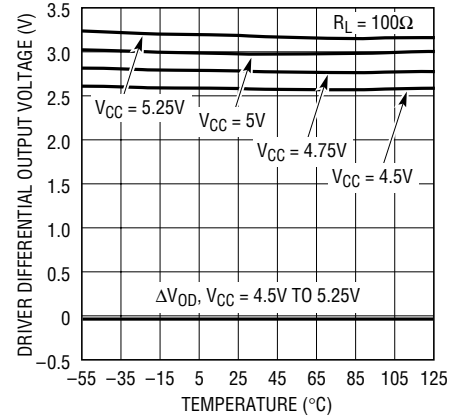

1482 G24

**Driver Common Mode Output Voltage vs Temperature**

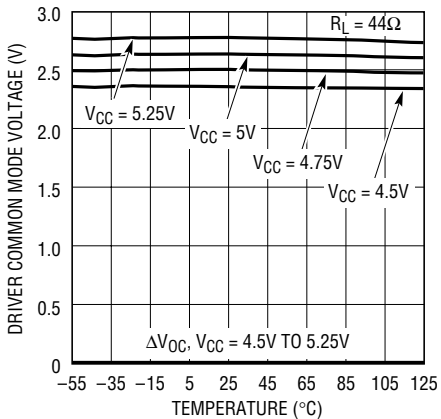

1482 G25

**Driver Common Mode Output Voltage vs Temperature**

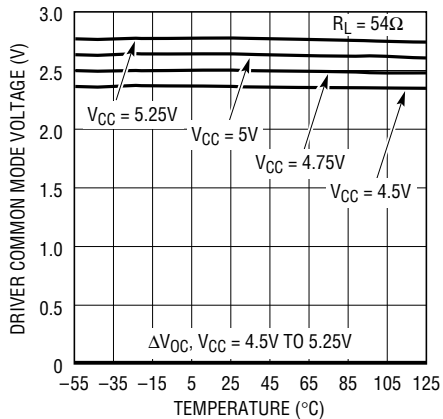

1482 G26

**Driver Common Mode Output Voltage vs Temperature**

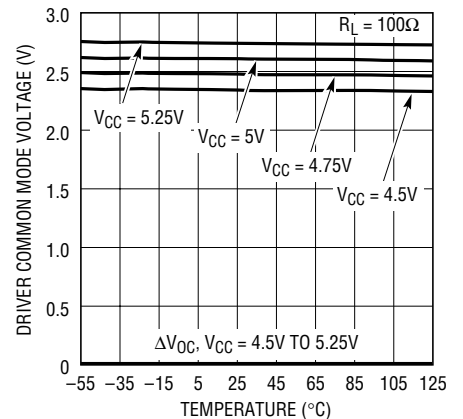

1482 G27

**Driver Differential Output Voltage vs Temperature**

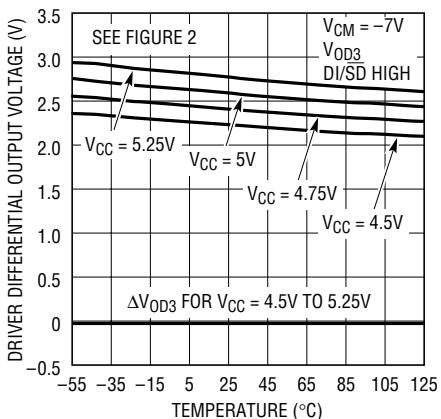

1482 G28

**Driver Differential Output Voltage vs Temperature**

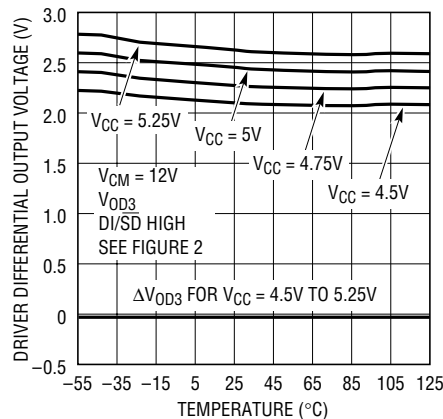

1482 G29

**Driver Differential Output Voltage vs Output Current**

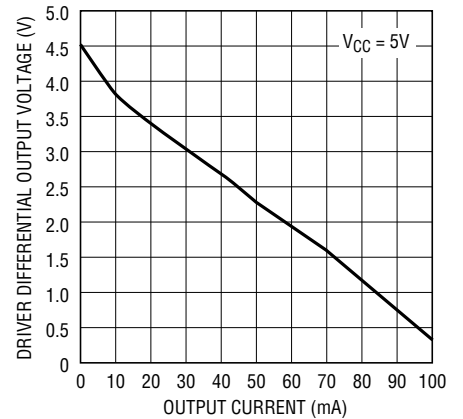

1482 G30



## TYPICAL PERFORMANCE CHARACTERISTICS

Driver Output High Voltage vs Output Current

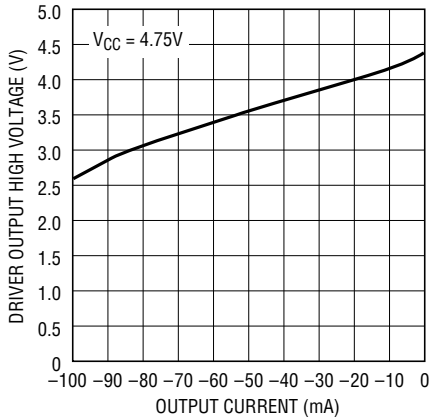

1482 G31

Driver Output Low Voltage vs Output Current

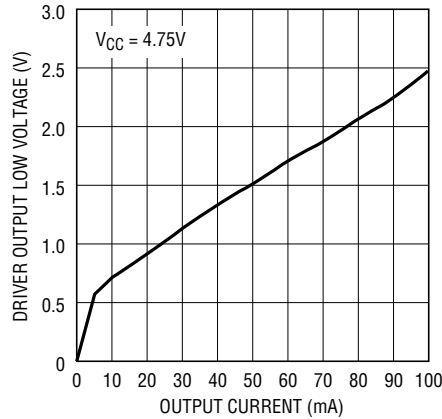

1482 G32

Driver Propagation Delay vs Temperature

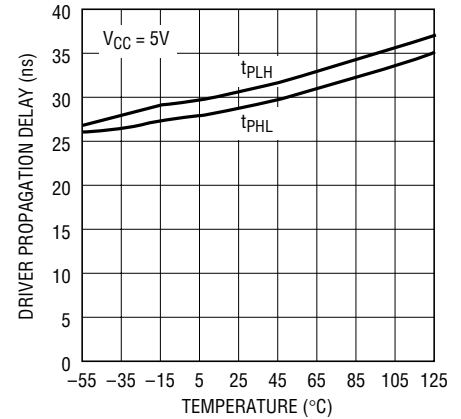

1482 G33

Driver Skew vs Temperature

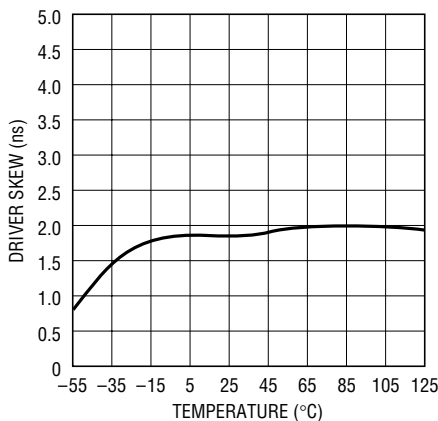

1482 G34

Driver Propagation Delay vs Supply Voltage

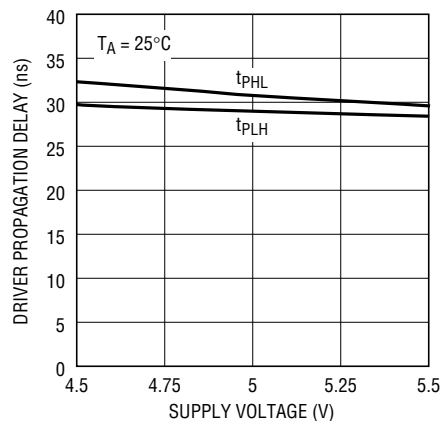

1482 G35

Driver Short-Circuit Current vs Temperature

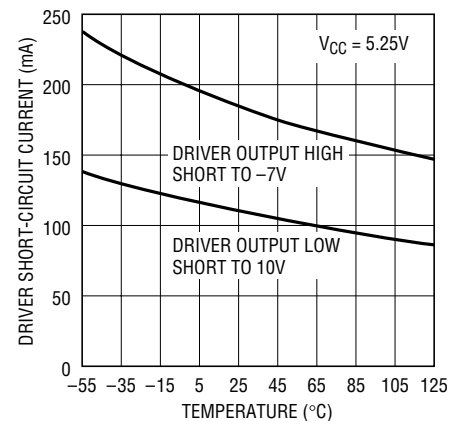

1482 G36

## PIN FUNCTIONS

**RO (Pin 1):** Receiver Output. If a carrier is present ( $\overline{CD}$  low) and the part is not in shutdown, RO is high if the receiver input differential voltage  $(A - B) \geq V_{THRO(MAX)}$  and low if  $(A - B) \leq V_{THRO(MIN)}$ . RO is forced to high (fail-safe state) if a carrier is not present ( $\overline{CD} = 1$ ). In shutdown, RO is three-stated. If the driver is enabled, RO follows the logic level at the driver input.

**$\overline{CD}$  (Pin 2):** Open-Drain Carrier Detect Output. Provided that the part is not in shutdown, the  $\overline{CD}$  output is low if  $V_{THCD(MIN)} \geq (A - B) \geq V_{THCD(MAX)}$  and high if  $V_{THCD(MIN)} < (A - B) < V_{THCD(MAX)}$ . This is true regardless of whether the A and B pins are driven by the internal ( $DE = 1$ ) or an

external ( $DE = 0$ ) driver. A weak internal pull-up removes the need for an external pull-up resistor if fast rise times are not important. Several LTC1482s can share the same  $\overline{CD}$  line.  $\overline{CD} = 1$  forces RO to the high fail-safe state. In shutdown,  $\overline{CD}$  is three-stated. This pin can be pulled above  $V_{CC}$  but should not be taken above 8V to avoid damage.

**DE (Pin 3):** Driver Enable Input.  $DE = 0$  disables or three-states the driver outputs.  $DE = 1$  enables the driver outputs with the high/low state of the outputs set by  $DI/\overline{SHDN}$ .

**$DI/\overline{SHDN}$  (Pin 4):** Driver Input and Shutdown Input. It is used together with the DE pin to put the part in shutdown



## PIN FUNCTIONS

(DE = 0, DI/ $\overline{\text{SHDN}}$  = 0) or to disable the driver while keeping the receiver alive (DE = 0, DI/ $\overline{\text{SHDN}}$  = 1). When the driver is enabled (DE = 1), DI/ $\overline{\text{SHDN}}$  = 0 forces the A output low and the B output high. DI/ $\overline{\text{SHDN}}$  = 1 forces the A output high and the B output low.

**GND (Pin 5):** Ground.

**A (Pin 6):** Driver Output/Receiver Input. The input resistance is typically 22k when the driver is disabled (DE = 0).

When the driver is enabled, the A output follows the logic level at the DI/ $\overline{\text{SHDN}}$  pin.

**B (Pin 7):** Driver Output/Receiver Input. The input resistance is typically 22k when the driver is disabled (DE = 0). When the driver is enabled, the B output is inverted from the logic level at the DI/ $\overline{\text{SHDN}}$  pin.

**V<sub>CC</sub> (Pin 8):** Positive Supply. 4.75V < V<sub>CC</sub> < 5.25V. A 0.1μF bypass capacitor is recommended.

## FUNCTION TABLES

### Driver Enabled (DE = 1)

DI/ $\overline{\text{SHDN}}$	A	B	RO	$\overline{\text{CD}}$
0	0	1	0	0
1	1	0	1	0
X	A Shorted to B		1	1

**Note 1:** DE = 0, DI/ $\overline{\text{SHDN}}$  = 0 puts the part in I<sub>CC</sub> shutdown and the supply current drawn by the V<sub>CC</sub> pin drops to 20μA max. The receiver is always alive except in shutdown.

**Note 2:** The table is valid regardless of the presence of an external termination resistor.

**Note 3:** Although the RO and the driver outputs are three-stated, the A and B pins each present a 22kΩ receiver input resistance to ground.

### Driver Disabled (DE = 0, Notes 1, 2)

DI/ $\overline{\text{SHDN}}$	A – B	RO	$\overline{\text{CD}}$
0	X (Note 3)	Z	1 (Internal Pull-Up)
1	V <sub>THCD(MIN)</sub> < (A – B) < V <sub>THCD(MAX)</sub>	1	1
1	A and B are Open	1	1
1	A and B are Shorted	1	1
1	V <sub>THCD(MIN)</sub> ≥ (A – B) ≥ V <sub>THCD(MAX)</sub> and (A – B) ≤ V <sub>THRO(MIN)</sub>	0	0
1	V <sub>THCD(MIN)</sub> ≥ (A – B) ≥ V <sub>THCD(MAX)</sub> and (A – B) ≥ V <sub>THRO(MAX)</sub>	1	0

X = Don't Care

Z = High Impedance

## TEST CIRCUITS

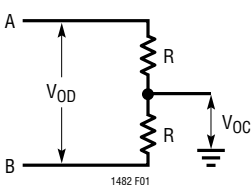

Figure 1. Driver DC Test Load #1

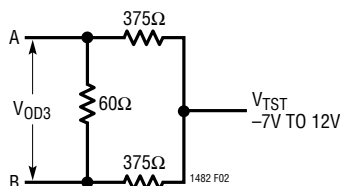

Figure 2. Driver DC Test Load #2

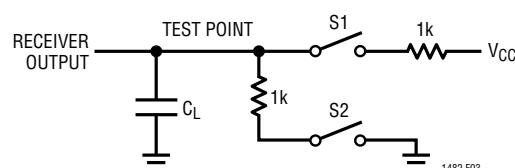

Figure 3. Receiver Timing Test Load

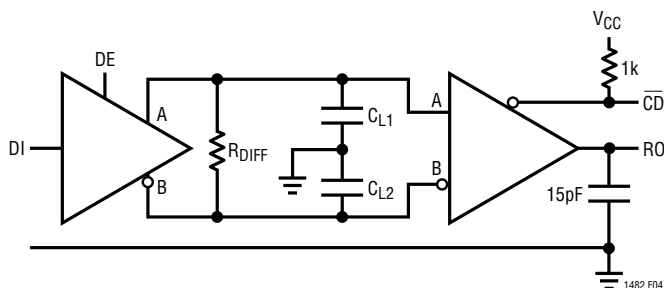

Figure 4. Driver/Receiver Timing Test Load

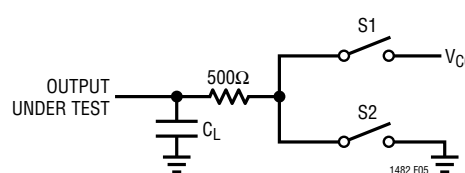

Figure 5. Driver Timing Test Load

# SWITCHING TIME WAVEFORMS

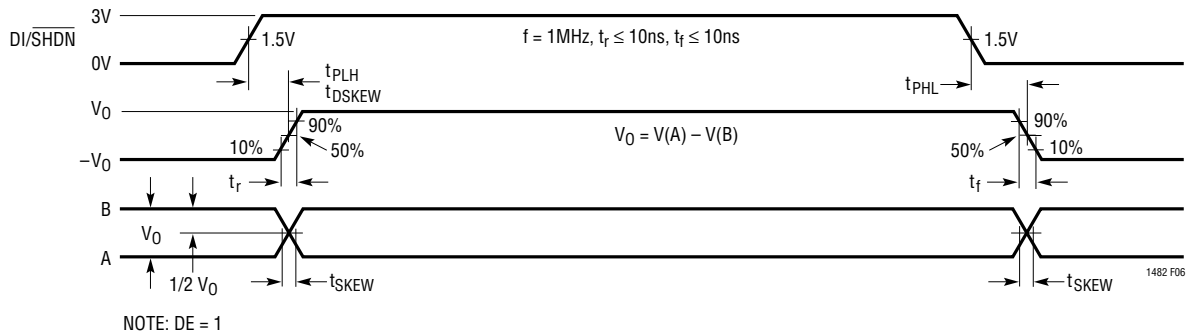

Figure 6. Driver Propagation Delays

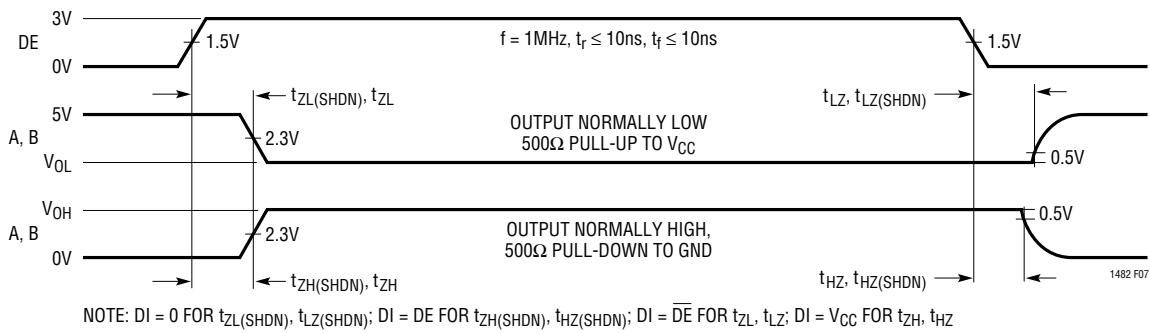

Figure 7. Driver Enable and Disable Timing

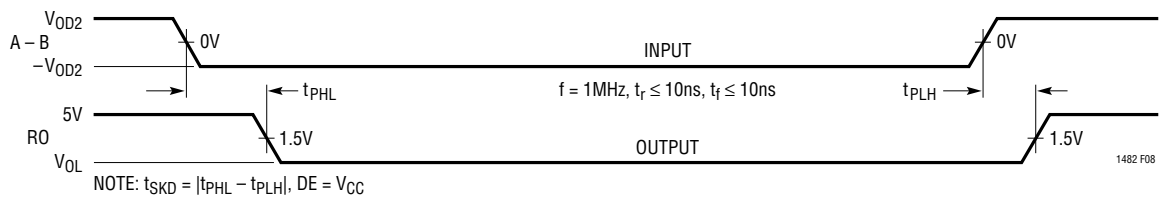

Figure 8. Receiver Propagation Delays

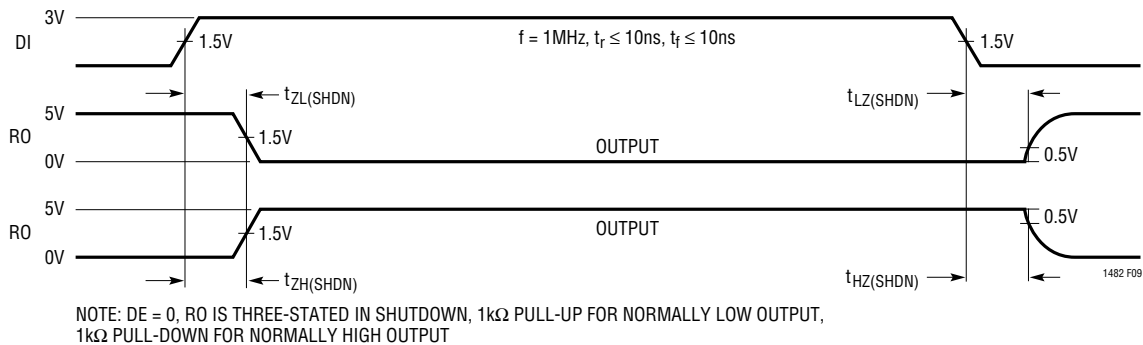

Figure 9. Receiver Enable and Shutdown Timing

# SWITCHING TIME WAVEFORMS

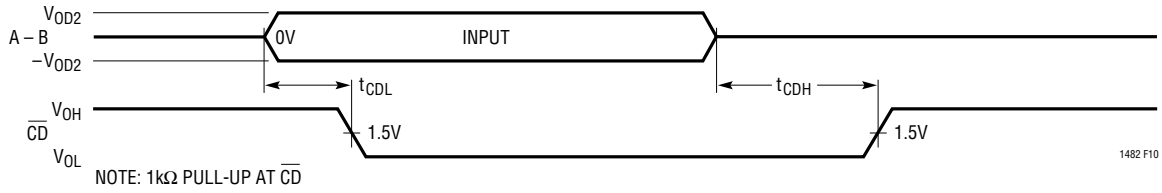

Figure 10. Carrier Detect Timing

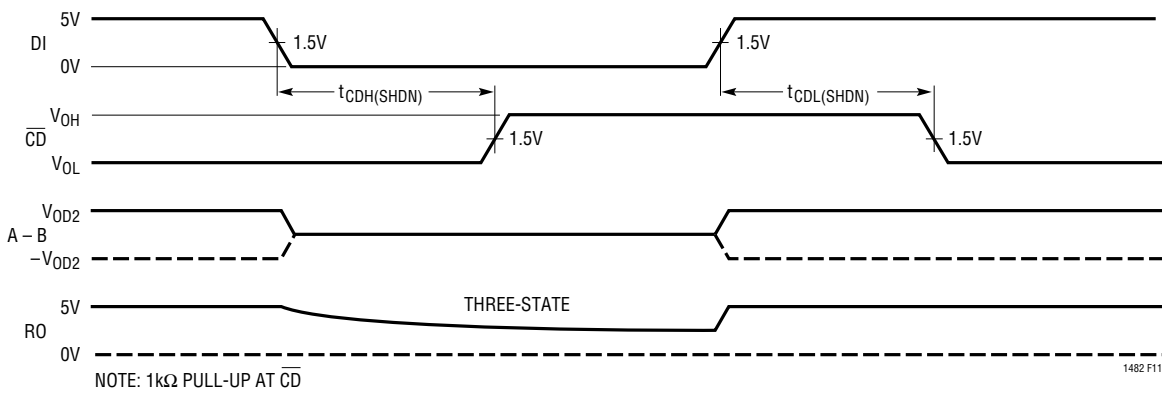

Figure 11. Shutdown Carrier Detect Timing

## APPLICATIONS INFORMATION

### Carrier Detect Operation

The carrier detect or  $\overline{CD}$  pin is an open-drain output with a weak internal pull-up (30 $\mu$ A typical). This allows several LTC1482s to share the same carrier detect line. The internal pull-up has a series diode, permitting users to tie the  $\overline{CD}$  output to a voltage higher than  $V_{CC}$  (8V max). When driving low, the  $\overline{CD}$  output can sink up to 4mA while maintaining the output below a TTL  $V_{OL}$  of 0.4V. An external pull-up resistor is recommended if fast rise times are important.

The LTC1482 defines the presence of a carrier as  $V_{THCD(MIN)} \geq (A - B) \geq V_{THCD(MAX)}$ .  $\overline{CD}$  pulls low when a carrier is present. When the carrier is absent, the weak internal pull-up pulls  $\overline{CD}$  high. For slow moving input signals (below about 32kHz for signals conforming to RS485 specifications), the  $\overline{CD}$  output will go high when the  $(A - B)$  signal is within the  $V_{THCD(MIN)}$  to  $V_{THCD(MAX)}$  range. For faster input signals, the  $\overline{CD}$  output does not glitch high when the  $(A - B)$  signal is traversing the transition region. This is achieved through internal delays in the  $\overline{CD}$  signal path. It takes  $t_{CDH} (\leq 5\mu s)$  for  $\overline{CD}$  to go high after the carrier signal is removed. There are no additional built-in delays for  $\overline{CD}$  going low so that  $t_{CDL}$  is only 300ns max.

When the LTC1482 is not in shutdown mode,  $\overline{CD} = 1$  always forces the receiver output (RO) high. If the driver is enabled ( $DE = 1$ ),  $\overline{CD} = 0$  as long as  $V_{THCD min} \geq (A - B) \geq V_{THCD max}$ . Shorting the A and B pins together or excessive loading between these pins will cause this condition to be violated and the  $\overline{CD}$  pin will pull high. If the driver is disabled,  $\overline{CD}$  is guaranteed to go high when:

- A is shorted to B,
- A and B are open (with or without termination) or
- $V_{THCD min} \leq A - B \leq V_{THCD max}$

The last condition occurs if the external driver is loaded excessively.

In shutdown mode, RO is three-stated and  $\overline{CD}$  is taken high by the weak internal pull-up. On exiting shutdown, it takes longer ( $t_{CDL(SHDN)} = 5\mu s$  max) for  $\overline{CD}$  to pull low when a carrier is present.

When  $V_{CC}$  is applied, some time is needed for  $\overline{CD}$  and RO to become valid. The time needed depends on the capacitance at the  $\overline{CD}$  pin, the  $V_{CC}$  rise time and the loads connected to the A and B pins. For a load capacitance of 15pF and a 1 $\mu s$   $V_{CC}$  rise time, a wait time of 10 $\mu s$  is recommended.

### Receiver Output and Fail-Safe

If  $\overline{CD}$  is low, the receiver output, RO, responds to the input differential voltage and is guaranteed (by testing) to go high if  $(A - B) \geq V_{THRO(MAX)}$  and low if  $(A - B) \leq V_{THCD(MIN)}$ .

Some data encoding schemes require that the output of the receiver maintain a known state (usually logic 1) when data transmission ends and all drivers on the line are forced into three-state. The carrier detect mechanism ensures that RO will be high regardless of whether the line is open, floating or shorted together, or whether the line is terminated or not. This removes external components required with earlier RS485 devices for the case where the required known state is a logic 1. External components are needed if the required state is a logic 0.

Fail-safe operates over the  $-7V$  to 12V common mode range and fast common mode steps do not affect the receiver output.

Note that the  $\overline{CD}$  output only goes high after all the drivers are three-stated due to built-in delays ( $t_{CDH}$ ) in the  $\overline{CD}$  signal path (see Carrier Detect Operation). During the time interval (see Figure 11) beginning at driver three-state and ending at  $\overline{CD}$  going high, the receiver output stays at the last state just prior to the driver three-stating.

### I<sub>CC</sub> Shutdown Mode

The supply current of the LTC1482 is reduced to 20 $\mu$ A max by taking both the DE and DI/SHDN pins low. In shutdown, all internal circuits are powered down and the driver and receiver outputs are three-stated. The  $\overline{CD}$  output is taken high by the weak internal pull-up.

Logic within the LTC1482 prevents slow DE and DI/SHDN transitions from generating internal shutdown pulses by rejecting "shutdown pulses" of less than 50ns (typ) in duration. Without this logic, the driver outputs will glitch when three-stated momentarily.

## APPLICATIONS INFORMATION

The supply current does not drop below 20 $\mu$ A immediately. DE and DI/SHDN must be low for a least 600ns simultaneously for  $I_{CC}$  to drop to half its operating value (driver outputs unloaded) and for  $t_{CDH(SHDN)}$  before dropping to the 20 $\mu$ A level. Taking either DE or DI/SHDN high will wake the LTC1482 within 5 $\mu$ s.

In some applications, the A and B lines are pulled to  $V_{CC}$  or GND through external resistors to force the line to a high or low state when all connected drivers are disabled. In shutdown, the supply current will be higher than 10 $\mu$ A due to the additional current drawn through the external pull-up and the 22k input resistance of the LTC1482.

### ESD Protection

The ESD performance of the LTC1482 A and B pins is characterized to meet  $\pm 15$ kV using the Human Body Model (100pF, 1.5k $\Omega$ ), IEC-1000-4-2 Level 4 ( $\pm 8$ kV) contact mode and IEC-1000-4-2 Level 3 ( $\pm 8$ kV) air discharge mode. This means that external voltage suppressors are not required in many applications, when compared with parts that are only protected to  $\pm 2$ kV. Pins other than the A and B pins are protected to  $\pm 3$ kV typical per the Human Body Model.

When powered up, the LTC1482 does not latch up or sustain damage when the A and B pins are tested using any of the three conditions listed. The data during the ESD event may be corrupted, but after the event the LTC1482 continues to operate normally. The additional ESD protection at the A and B pins is important in applications where these pins are exposed to the external world via connections to sockets.

### Fault Protection

When shorted to  $-7$ V or 10V at room temperature, the short-circuit current in the driver pins is limited by internal protection circuitry to 250mA. Over the industrial temperature range, the absolute maximum positive voltage at any driver pin should be limited to 10V to avoid damage to the part. At higher ambient temperatures, the rise in die temperature, due to the short-circuit current, may trip the thermal shutdown circuit. This circuit protects the part against prolonged shorts at the driver outputs. If a driver output is shorted to another output or to  $V_{CC}$ , the current will be limited to 250mA. If the die temperature rises above 150 $^{\circ}$ C, the thermal shutdown circuit three-states the driver outputs to open the current path. When the die cools down to about 130 $^{\circ}$ C, the driver outputs are taken out of three-state. If the short persists, the part will heat again and the cycle will repeat. This thermal oscillation occurs at about 10Hz and protects the part from excessive power dissipation. The average fault current drops as the driver cycles between active and three-state. When the short is removed, the part will return to normal operation.

When the driver is disabled, the receiver inputs can withstand the entire  $-7$ V to 12V RS485 common mode range without damage.

**PACKAGE DESCRIPTION** Dimensions in inches (millimeters), unless otherwise noted.

**MS8 Package**  
**8-Lead Plastic MSOP**  
 (LTC DWG # 05-08-1660)

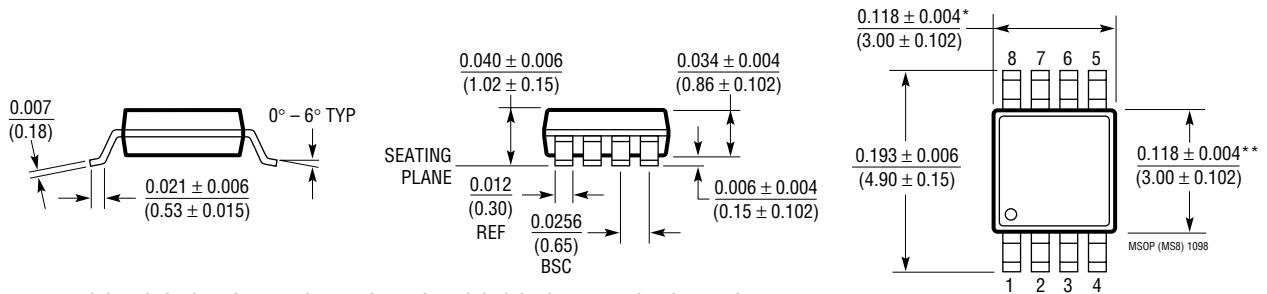

- \* DIMENSION DOES NOT INCLUDE MOLD FLASH, PROTRUSIONS OR GATE BURRS. MOLD FLASH, PROTRUSIONS OR GATE BURRS SHALL NOT EXCEED 0.006" (0.152mm) PER SIDE
- \*\* DIMENSION DOES NOT INCLUDE INTERLEAD FLASH OR PROTRUSIONS. INTERLEAD FLASH OR PROTRUSIONS SHALL NOT EXCEED 0.006" (0.152mm) PER SIDE

**N8 Package**  
**8-Lead PDIP (Narrow 0.300)**  
 (LTC DWG # 05-08-1510)

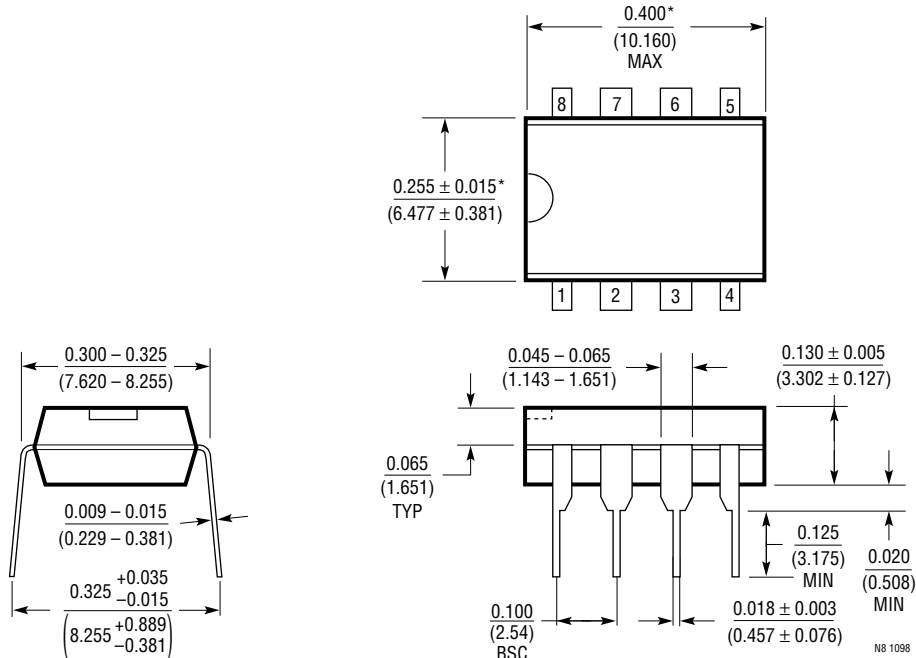

- \*THESE DIMENSIONS DO NOT INCLUDE MOLD FLASH OR PROTRUSIONS. MOLD FLASH OR PROTRUSIONS SHALL NOT EXCEED 0.010 INCH (0.254mm)

**PACKAGE DESCRIPTION** Dimensions in inches (millimeters), unless otherwise noted.

**S8 Package**  
**8-Lead Plastic Small Outline (Narrow 0.150)**  
 (LTC DWG # 05-08-1610)

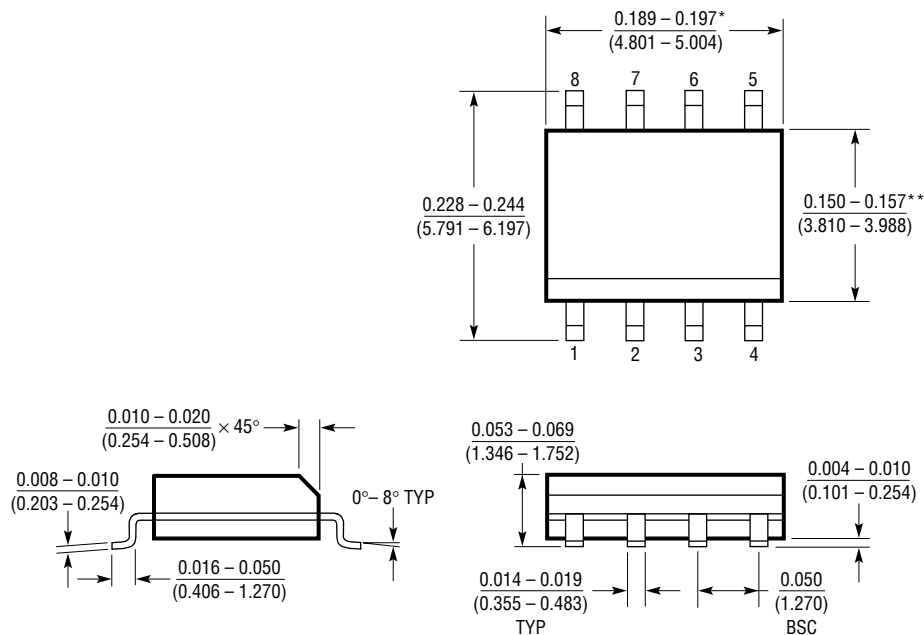

\*DIMENSION DOES NOT INCLUDE MOLD FLASH. MOLD FLASH SHALL NOT EXCEED 0.006" (0.152mm) PER SIDE  
 \*\*DIMENSION DOES NOT INCLUDE INTERLEAD FLASH. INTERLEAD FLASH SHALL NOT EXCEED 0.010" (0.254mm) PER SIDE

S08 1298



